



# ShanPu

## Navigation Switches Series SPD5K2

**NEW**

Applicable on 1U case.



<b>General Specifications</b>	
Circuit	:SPST (Switch element)
Current Rating	:50mA @ 12VDC
Contact Resistance	:100mOhm Max.(initial)
Insulation Resistance	:100MOhm Min.
Operating Force	:300gf±50gf
Total Travel	:0.3mm±0.1mm
Operating Life	:1,000,000 cycles Min.
Operating Temperature	:-10 deg.~+60 deg.
Solder Specifications	:260 deg. for 3 seconds
<b>Materials</b>	
Cap	:Polycarbonate (PC)
Reflector	:Polyamide(PA)
Base	:LCP
Action Dome	:Stainless steel with silver plating
Terminal	:Phosphor bronze (PBS) with gold plating

We provide Laser Marking service.

### PCB. layout & Panel cutting

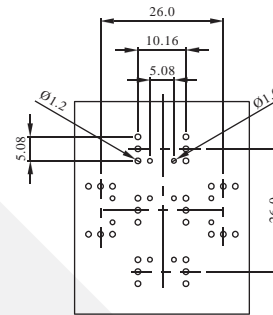

PCB layout TH

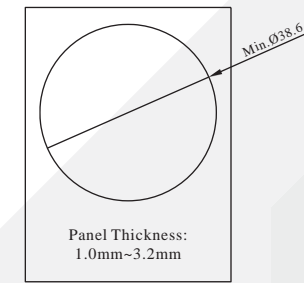

Panel cutting

### Contact Configuration

L5 L4 L3 L2 L1 L+ S5 S4 S3 S2 S1 SC

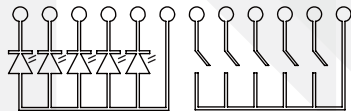

Configuration

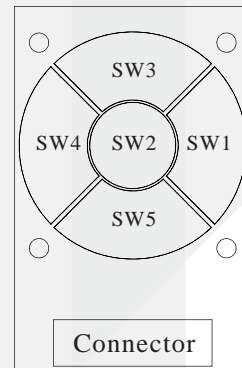

Connector

### Dimension

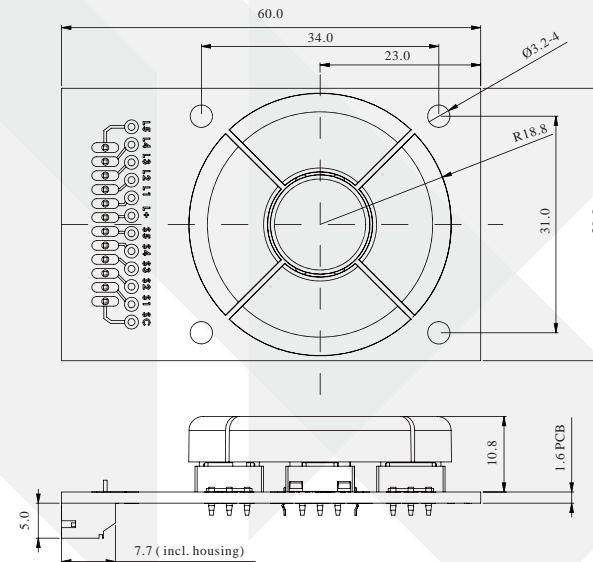



## Navigation Switches Series **SPD5K2**

### How to Order

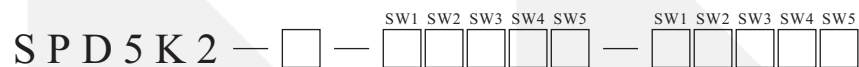

CAP Style		
Module Type	SW2	SW1,3,4,5
A	YCA017	YCA018

Switch LED Color					
SW1	SW2	SW3	SW4	SW5	
		0			without LED
		1			Red
		2			Yellow
		3			Green
		4			White
		7			Blue
		P			Pure Green

CAP/Color					
SW1	SW2	SW3	SW4	SW5	
		1			Red
		2			Yellow
		3			Green
		4			White
		5			Black
		6			Orange
		7			Blue
		9			Grey
		B			Snow

LED use Snow color cap only.

### Accessory



Connector: YCN003

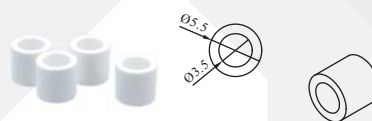
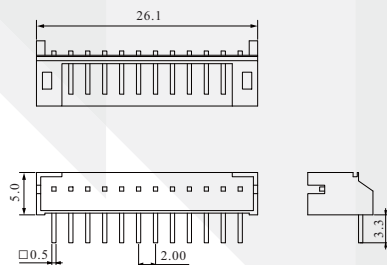



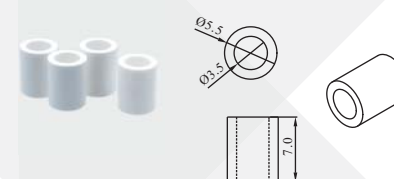



Spacer Support : YPA008



Spacer Support : YPA009



## SPD5K2 Standard Module

<b>Module</b>							
<b>Part No</b>	SPD5K2-AM001	SPD5K2-AM002	SPD5K2 -AM003	SPD5K2-AM004	SPD5K2-AM005	SPD5K2-AM006	SPD5K2-AM007
<b>Description</b>	Black Cap with white print Without LED	Cap Painted White with Laser etching Pure Green LED	Cap Painted Green with Laser etching Red LED	Cap Painted Black with Laser etching Red LED	Cap Painted Silver with Laser etching Blue LED	Cap Painted Blue with Laser etching Yellow LED	Cap Painted Red with Laser etching Blue LED

Color is subject to actual product.