

高精密超薄金鋼石切割片

高精密超薄金剛石切割片是我院開發的系列產品之一。主要用於光電資訊材料的精密加工，包括光學玻璃、磁性材料、半導體材料、晶體、精細陶瓷等脆性非金屬材料及硬質合金、模具鋼等材料的開槽、切割加工。

獨特的工藝使切割更精細、平穩，切口損失小，切割面更為平滑。



中鋼洛耐院高精密超薄切割片的典型應用：

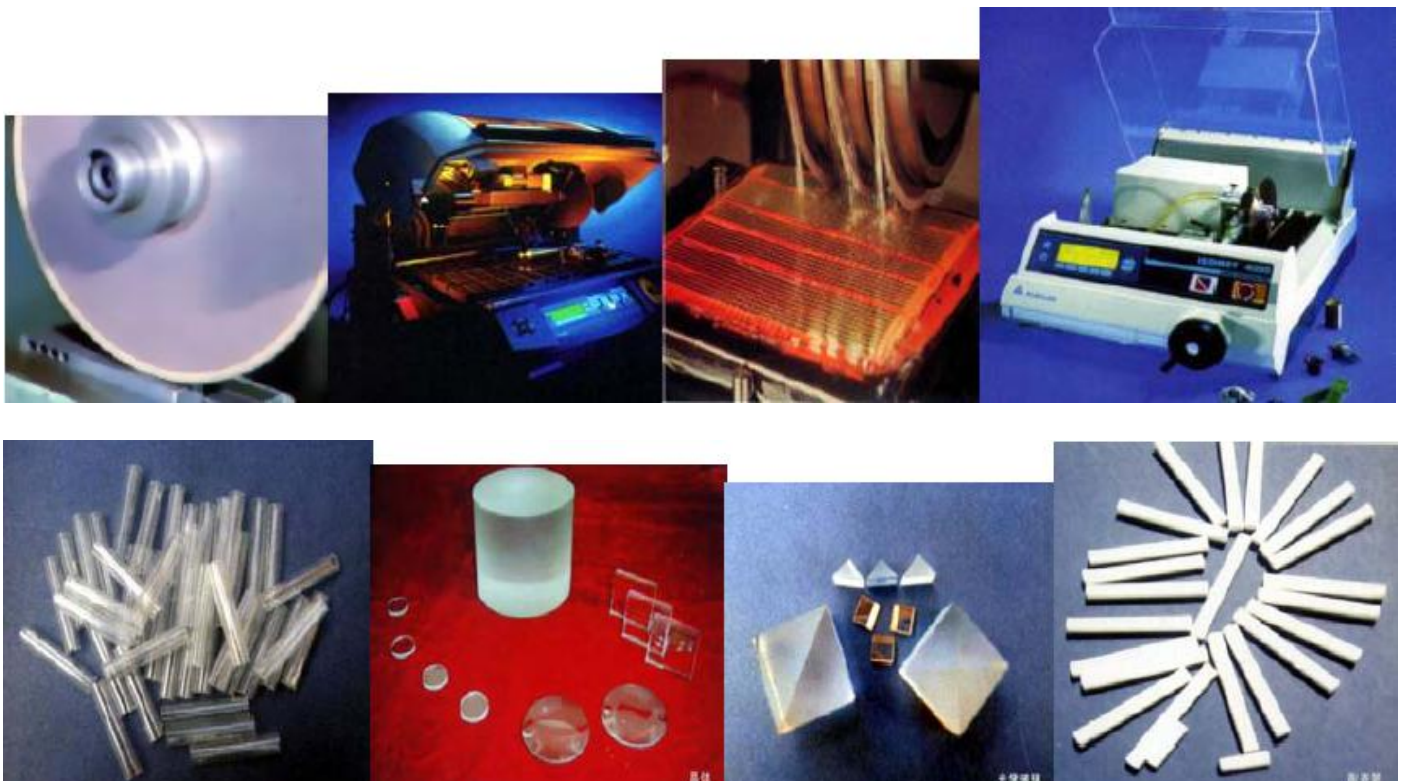

外環式金屬結合式切割片

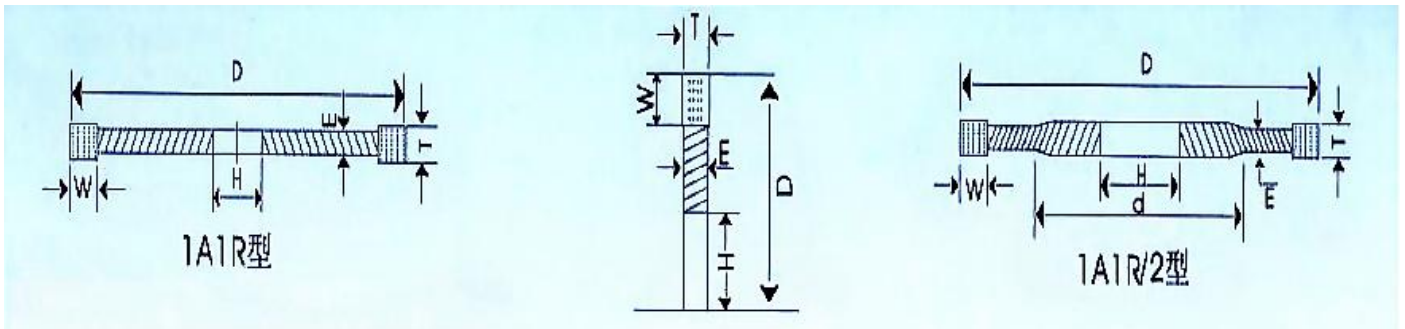

● 選擇標準 (Standard blade types) (mm)

厚度 (T)	0.4~0.6	0.5~0.8	0.7~1.0	0.9~1.2	1.0~1.5
細微性 (Grit size)	200~600	180~600	150~600	120~600	100~400

T \ D	(mm)										精度
	60	76.2	80	100	115	125	150	175	180	200	
0.4											±0.004
0.5											±0.004
0.6											±0.004
0.7											±0.005
0.8											±0.005
1.0											±0.005
1.2											±0.005
1.5											±0.005
(內孔尺寸) H	12.7, 19.05, 22.22, 25.4, 31.75, 32, 40, 50, 75										

樹脂結合劑切割片

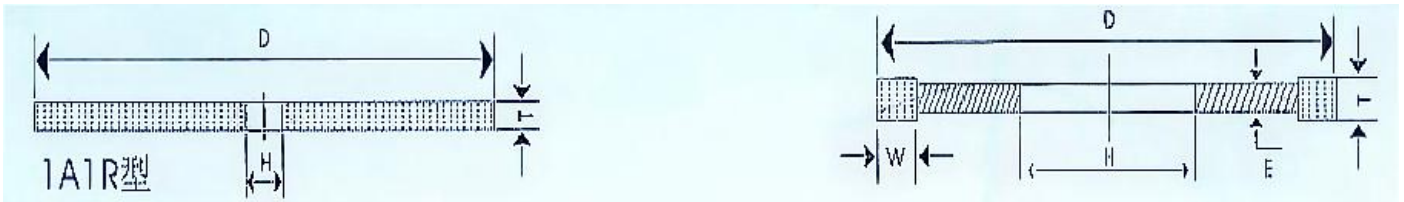

● 選擇標準 (Standard blade types) (mm)

厚度 (T)	0.4~0.6	0.5~0.8	0.7~1.0	0.9~1.2	1.4~2.0
細微性 (Grit size)	200~600	400~1500	400~120	320~100	320~100

T \ D	60	76.2	80	100	115	125	150	175	180	200	精度
0.4											±0.004
0.5											±0.004
0.6											±0.004
0.7											±0.005
0.8											±0.005
1.0											±0.005
1.2											±0.005
1.5											±0.005
(內孔尺寸) H	12.7, 19.05, 22.22, 25.4, 31.75, 32, 40, 50, 75										

整體式精密切割片

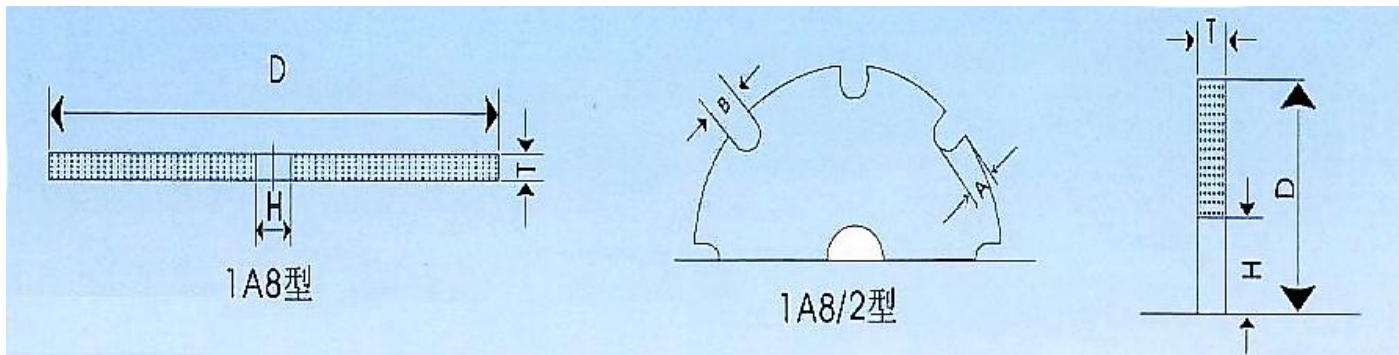
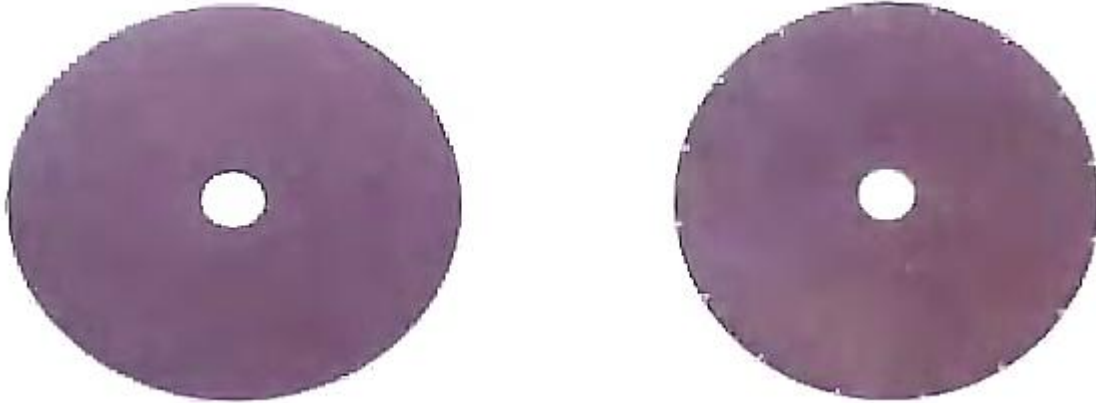

● 選擇標準 (Standard blade types)

厚度 (T)	0.1	0.15	0.2	0.25	0.30	0.40	0.50
細微性 (Grit size)	600~6000	500~6000	400~6000	400~6000	400~6000	325~6000	325~6000

T \ D	50.8	56	76.2	101.2	114.3	精度
0.1						±0.002
0.15						±0.002
0.20						±0.002
0.30						±0.002
0.40						±0.002
0.50						±0.002
(內孔尺寸) H	12.7, 19.05, 25.4, 31.75, 40					

高精密金屬結合劃片

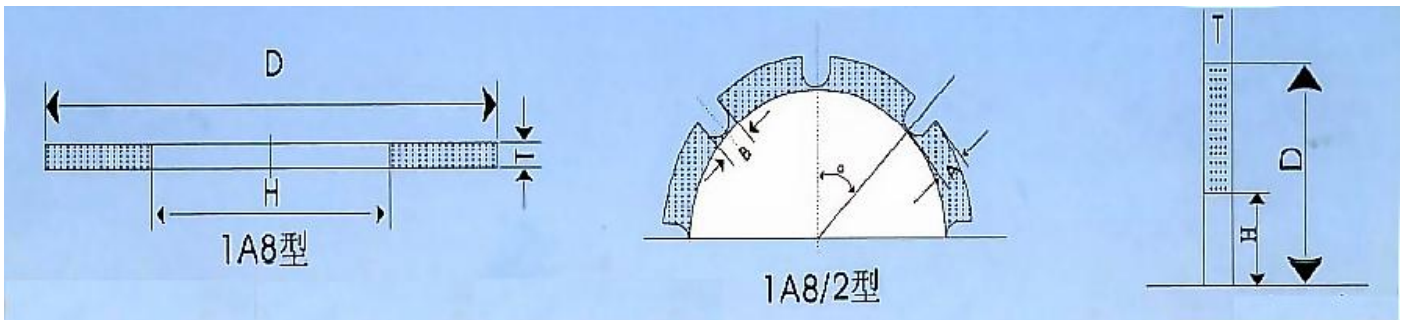
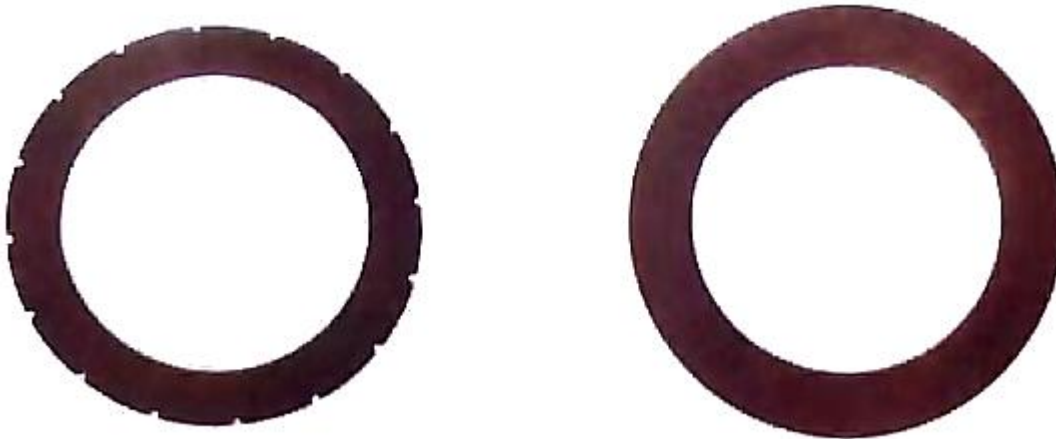

● 選擇標準 (Standard blade types) (mm)

厚度 (T)	0.1	0.15	0.2	0.25	0.30	0.40	0.50
細微性 (Grit size)	600~6000	500~6000	400~6000	400~6000	400~6000	325~6000	325~6000

(mm)

T \ D	50.8	57.8	76.2	101.2	114.3	精度
0.1						±0.002
0.15						±0.002
0.20						±0.002
0.30						±0.002
0.40						±0.002
0.50						±0.002
(內孔尺寸) H	40, 55, 50.8, 69.88, 88.9					